

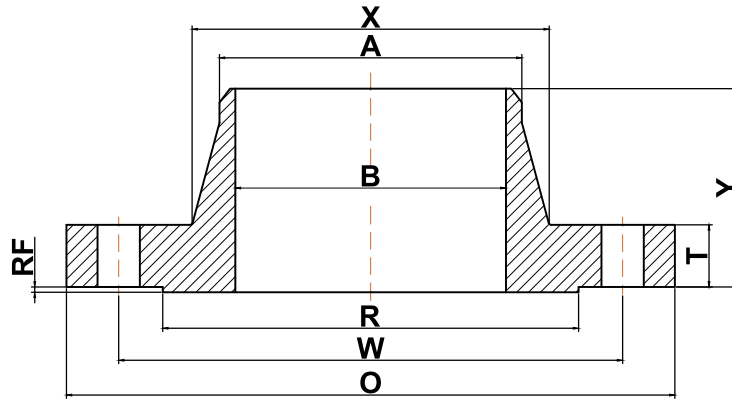

ANSI b16.5

▶ Class 400 Welding Neck Flanges



Nominal Pipe Size	Outside Diameter (O)	Bolt Circle (W)	Raised Face Diameter (R)	Number of Holes	Diameter of Holes	Bore (B)	Point of Weld (A)	Hub Diameter (X)	Thickness (T)	Length Thru Hub (Y)	Approximate Weight (lbs)
1/2	3.75	2.62	1.38	4	0.63	Specified by purchaser	0.84	1.50	0.56	2.06	2
3/4	4.62	3.25	1.69	4	0.75	Specified by purchaser	1.05	1.88	0.62	2.25	4
1	4.88	3.50	2.00	4	0.75	Specified by purchaser	1.32	2.12	0.69	2.44	4
1 1/4	5.25	3.88	2.50	4	0.75	Specified by purchaser	1.66	2.50	0.81	2.63	6
1 1/2	6.12	4.50	2.88	4	0.88	Specified by purchaser	1.90	2.75	0.88	2.75	8
2	6.50	5.00	3.62	8	0.75	Specified by purchaser	2.38	3.31	1.00	2.88	12
2 1/2	7.50	5.88	4.12	8	0.88	Specified by purchaser	2.88	3.94	1.12	3.12	18
3	8.25	6.62	5.00	8	0.88	Specified by purchaser	3.50	4.62	1.25	3.25	23
3 1/2	9.00	7.25	5.50	8	1.00	Specified by purchaser	4.00	5.25	1.38	3.38	26
4	10.00	7.88	6.19	8	1.00	Specified by purchaser	4.50	5.75	1.38	3.50	35
5	11.00	9.25	7.31	8	1.00	Specified by purchaser	5.56	7.00	1.50	4.00	43
6	12.50	10.62	8.50	12	1.00	Specified by purchaser	6.63	8.12	1.62	4.06	57
8	15.00	13.00	10.62	12	1.13	Specified by purchaser	8.63	10.25	1.88	4.62	89
10	17.50	15.25	12.75	16	1.25	Specified by purchaser	10.75	12.62	2.12	4.88	125
12	20.50	17.75	15.00	16	1.38	Specified by purchaser	12.75	14.75	2.25	5.38	175
14	23.00	20.25	16.25	20	1.38	Specified by purchaser	14.00	16.75	2.38	5.88	230
16	25.50	22.50	18.50	20	1.50	Specified by purchaser	16.00	19.00	2.50	6.00	295
18	28.00	24.75	21.00	24	1.50	Specified by purchaser	18.00	21.00	2.62	6.50	350
20	30.50	27.00	23.00	24	1.63	Specified by purchaser	20.00	23.13	2.75	6.62	425
22	33.00	29.25	25.25	24	1.75	Specified by purchaser	22.00	25.25	2.88	6.75	505
24	36.00	32.00	27.25	24	1.88	Specified by purchaser	24.00	27.62	3.00	6.88	620

(a) All dimensions are in inches

(b) These flanges will be furnished with a 1/4" raised face unless otherwise specified.